

# 160W Constant Voltage Slim-US Series



## Features

- Class II, SELV, independent
- Input Voltage 220-240VAC
- Protections: SCP/OLP/OTP
- Power Factor > 0.95
- Efficiency ≥92%
- 5 years warranty

## Applications

- LED strips kitchen light



## ◆ Description

US-160-XX LI1 is a 160W constant voltage LED driver that operates from 198-264Vac input with 24V or 48V output voltage. With it's compact dimensions from 395 x 30.5 x 21.5mm it is easy to integrate in LED strips, kitchen light products. To ensure trouble-free operation, protection is provided against output short circuit and over Load.

## ◆ Model code

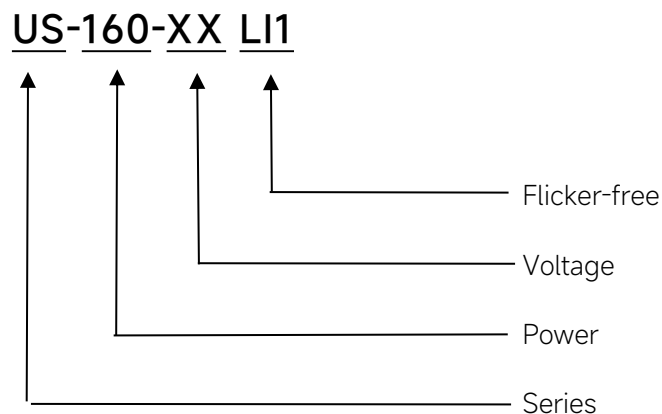

## ◆ Specification

Output	Constant Voltage	24VDC	48VDC
	Current Range	0-6.67A	0-3.33A
	Voltage Accuracy	±5%	
	Output HF current ripple(≥1KHz)	±1%	
	Output LF current ripple(≤120Hz)	±1%	
	SVM	≤0.4@Full Load	
	Pst	≤1@Full Load	
	Efficiency(Typ.)	≥92%	
Input	Rated input voltage	220-240VAC	
	Range of input voltage	198-264VAC	
	Rated input voltage(DC)	176-250VDC	
	Frequency(Hz)	0/50/60 Hz	
	Power Factor	≥0.95	
	Input Current max	1A	
	Start-up time	< 0.5S	
	No Load Power	≤0.5W	
	THD (Typ.)	< 8%	
Protection	Over Load Protection	105-150%	
		YES/Auto Resume	
	Short circuit Protection	YES/Auto Resume	
	Over Temperature Protection	YES/Auto Resume	
Environment	Operating Temperature	-20°C~+45°C	
	Humidity	20%-90%RH	
	Tc	80°C	90°C
	Storage Temperature	-20°C~+60°C	
	Life time	> 50000h@Tc=80°C,230VAC	
Surface	Dimension	395X30.5X21.5(LXWXH)mm	
standards	EN 61347-1; EN61347-2-13; EN62384; EN55015; EN61000-3-2 ; EN61000-3-3; EN 61547;		
Others	ErP	EU 2019/2020	
	RoHS	RoHS (2011/65/EU) (EU)2015/863	
Note	1.All parameters NOT specially mentioned are measured at 230VAC input , full load and 25°C of ambient temperature. Ripple & Noise are measured at 20MHz of bandwidth by using a 300mm twisted pair-wire terminated with a 0.1uF & 47 uF parallel capacitor.		

◆ Wiring diagram

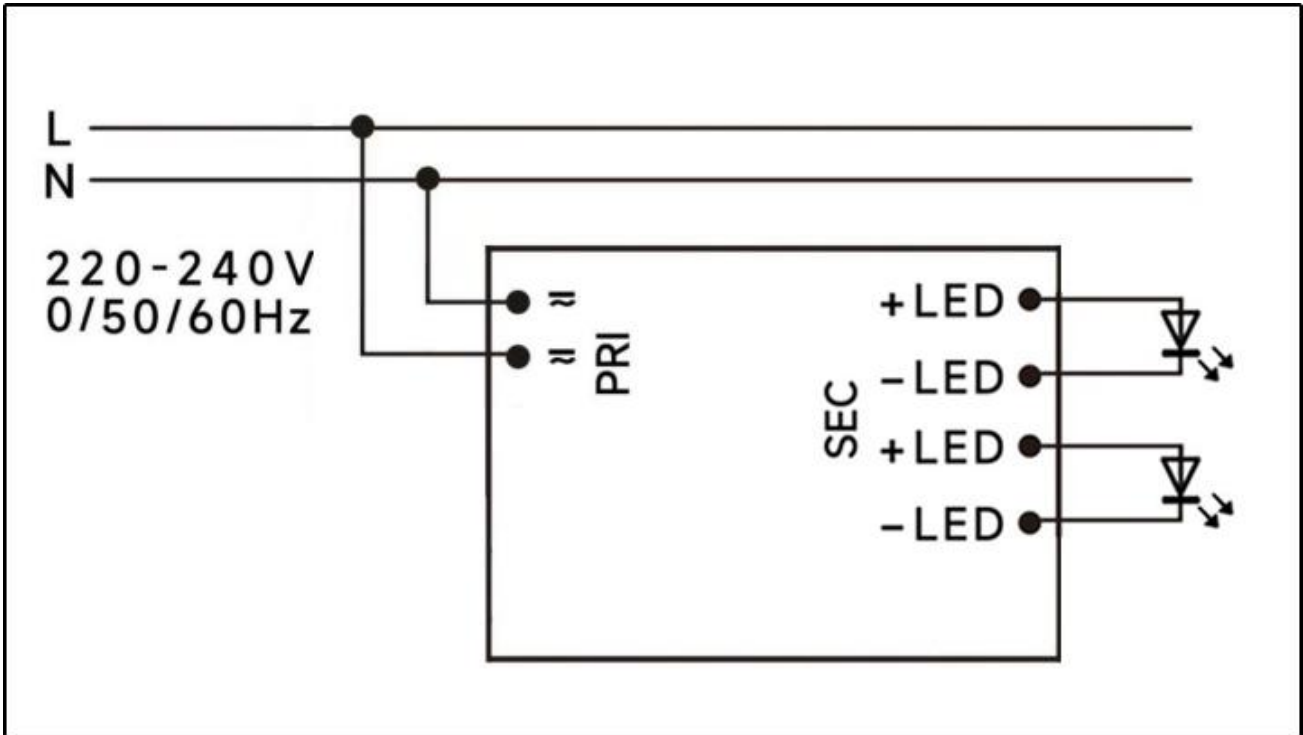

◆ 2D diagram

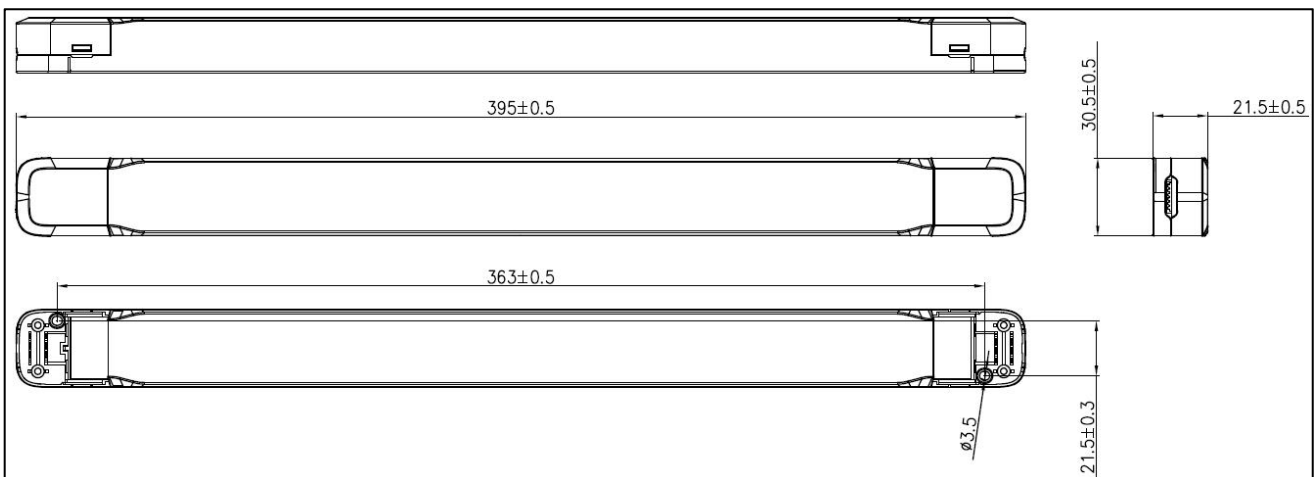

◆ **Curve for US-160-12 LI1**

Lifetime vs. Temperature Curve

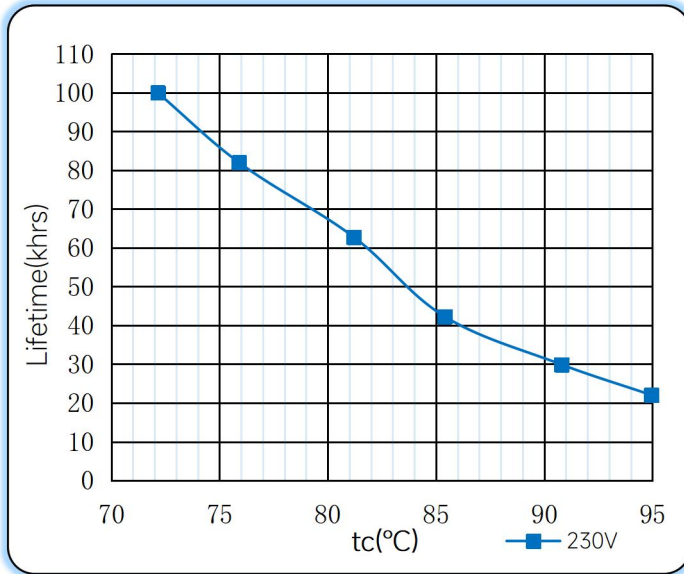

Efficiency vs. Load

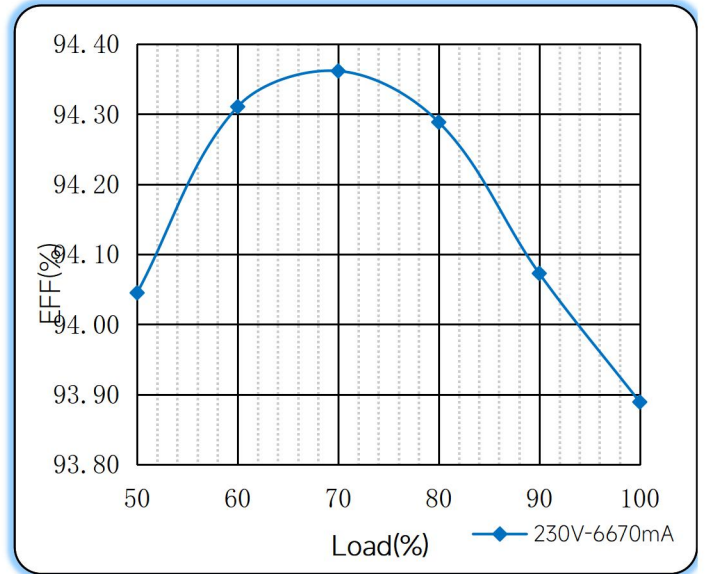

Power Factor Characteristics

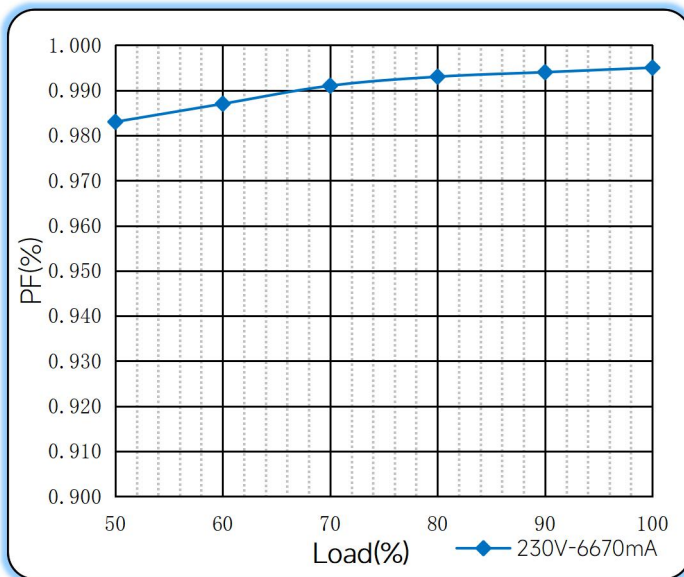

THD vs. Load

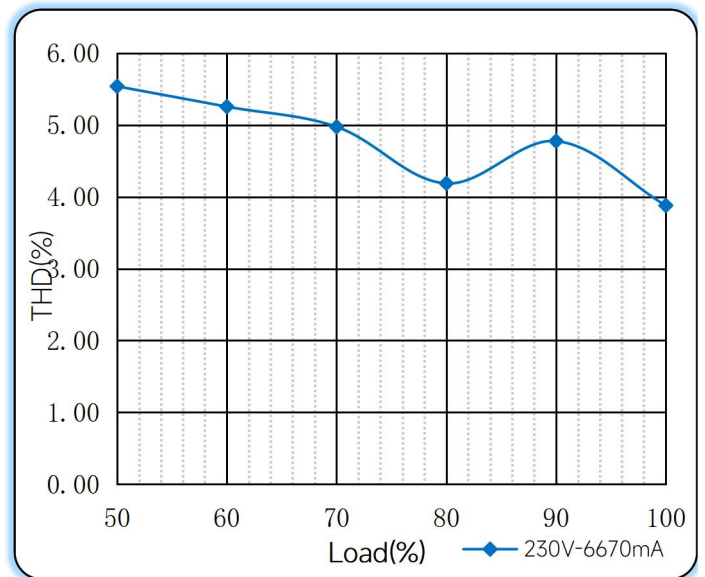

### ◆ Operating window

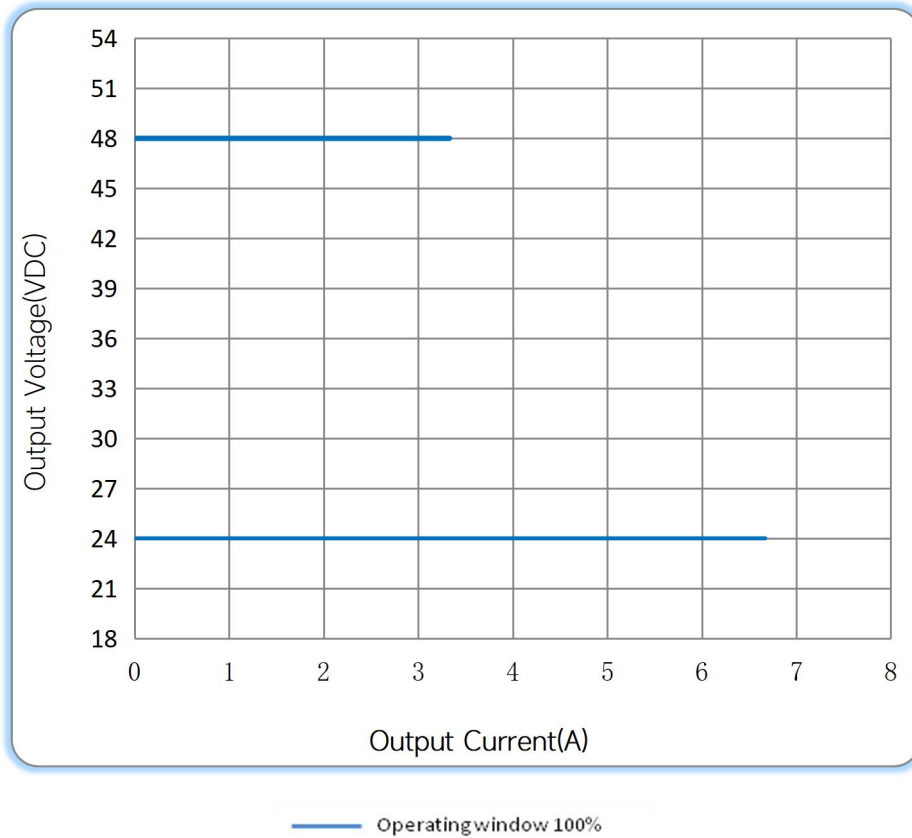

### ◆ Revision Updates

ITEM	BEFORE	AFTER	VERSION	DATE
Initial			A	2022/05/15

Tel: +86-0757-86256822, +86-0757-86256831

E-mail: sales@eaglerise.com

Website : <https://lighting.eaglerise.com>



EAGLERISE



Manual